



Authorized Distributor:  
Pacific Marine & Industrial  
www.pacificmarine.net  
info@pacificmarine.net

# Worm Gear Drive

Part Number: 83081

Model: HFG430D

Est Weight: 59 lb 1/7/2020

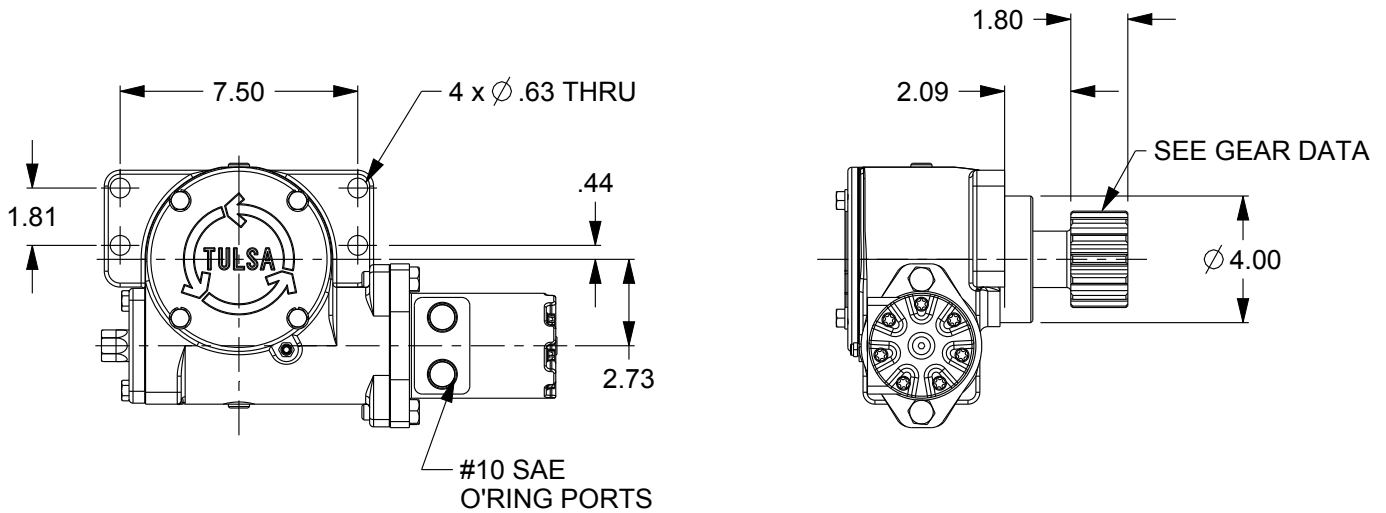
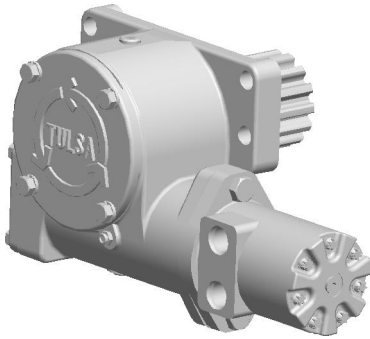

Performance Data		Gear Data	
Ratio	30:1	Number of Teeth	14
Output Torque - (in lb)	6,000	Diametral Pitch	5/7
Output RPM	30.5	Pitch Diameter	2.800
Hydraulic Pressure - (psi)	1700	Pressure Angle	20°
Flow Maximum - (gpm)	12		

Contact your dp sales representative for additional options and features not shown.

Because of continued product improvement, we reserve the right to make changes without notice.

<b>⚠ WARNING</b>	<b>⚠ CAUTION</b>
Winches are not intended to be used for the lifting or moving of persons.	The last 5 wraps cable must be left on the drum to assist the cable clamp in holding the load.

### Contact Us Today

TWG Headquarters, 11135 S James Ave  
Jenks, OK 74037 USA  
(918) 298-8300 | salesinfo@dovertwg.com

### Contact Us Today

TWG Canada, 19350 22nd Ave  
Surrey, BC V3Z 3S6 CANADA  
(604) 547-2100 | salesinfo@dovertwg.com

